



Applicable sockets:
SO-1066-10385/10386

Application Notes:
102
007

• All welded construction

• Contact arrangement 4 PDT

• Meets the standards and requirements of MIL-PRF-83536

PRINCIPLE TECHNICAL CHARACTERISTICS

• Contacts rated at	Low level, 28 Vdc and 115/200 Vac, 400 Hz, 3Ø, case grounded
• Weight	0.066 lb max
• Dimensions	0.81 in x 0.81 in x 0.64 in
• Special models available upon request	
• Hermetically sealed, corrosion resistant metal can	

CONTACT ELECTRICAL CHARACTERISTICS

Contact rating per pole and load type [1]	Load current in Amps		
	28 Vdc	115 Vac, 400 Hz, 1Ø	115/200 Vac, 400 Hz, 3Ø
Resistive	5	5	5
Inductive [2]	3	5	5
Motor	2	3	3
Lamp	1	1	-
Overload	20	30	30
Rupture	25	40	40
Low level [3]	-	-	-
Time current characteristics [4]	-	-	-

COIL CHARACTERISTICS (Vdc)

CODE	Vac 400 Hz	Vac 50 thru 400 Hz	
	F	J	K
Nominal operating voltage	115	28	115
Maximum operating voltage	122	30	122
Maximum pickup voltage			
- Cold coil at +85° C	90	23	95
- During high temp test at +85° C	95.4	24.6	100
- During continuous current test at +85° C	103.5	25.9	105
Maximum drop-out voltage	30	10	30
Coil current maximum milliAmperes at +25° C	40	120	28

GENERAL CHARACTERISTICS

Temperature range	-70°C to 85°C
Minimum operating cycles (life) at rated load	50,000 [2]
Minimum operating cycles (life) at 25% rated load	200,000
Dielectric strength at sea level - All circuits to ground and circuit to circuit	1050 Vrms
Dielectric strength at sea level - Coil to ground	1050 Vrms
Dielectric strength at altitude 80,000 ft	500 Vrms [5]
Insulation resistance - Initial (500 Vdc)	100 M Ω min
Insulation resistance - After environmental tests (500 Vdc)	50 M Ω min
Sinusoidal vibration (A and D mounting)	0.12 d.a. / 10 to 70 Hz 30G / 70 to 3000 Hz
Sinusoidal vibration (G and J mounting)	0.12 d.a. / 10 to 57 Hz 20G / 57 to 3000 Hz
Random vibration	
- Applicable specification	MIL-STD-202
- Method	214
- Test condition - A and D mounting	1G (0.4G ² /Hz, 50 to 2000 Hz)
- Test condition - G and J mounting	1E (0.2G ² /Hz, 50 to 2000 Hz)
- Duration	15 minutes each plane
Shock (A and D mounting)	200G / 6 ms
Shock (G and J mounting)	100G / 6 ms
Maximum contact opening time under vibration and shock	10 μs
Operate time at nominal voltage @25°C	15 ms max
Release time at nominal voltage @25°C	25 ms max
Contact make bounce at nominal voltage @25°C	1 ms max
Contact release break bounce at nominal voltage @25°C	0.5 ms max

Unless otherwise noted, the specified temperature range applies to all relay characteristics.

Dimensions in inches
Tolerances, unless otherwise specified, XX ± 0.03 in., XXX ± 0.010

MOUNTING STYLES

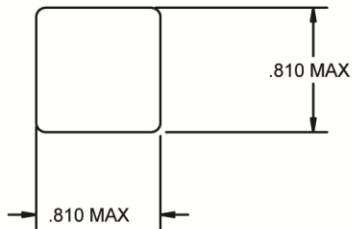
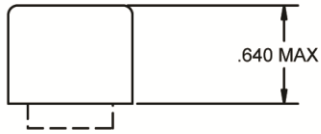

MOUNTING STYLE A

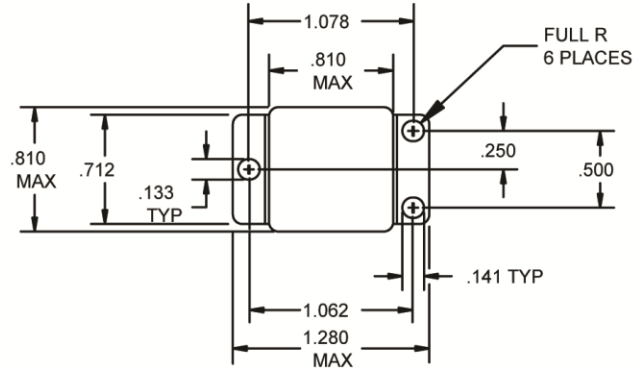
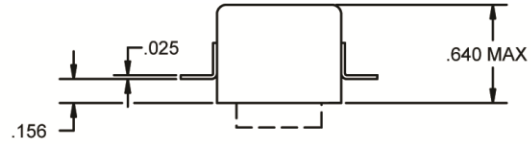

MOUNTING STYLE D

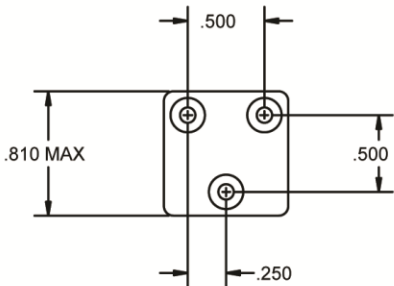
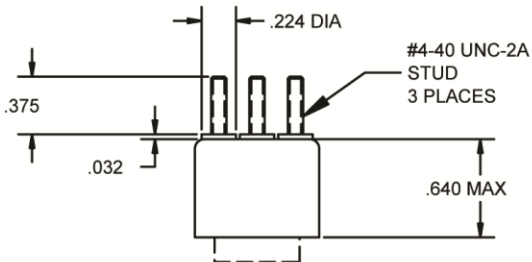

MOUNTING STYLE G

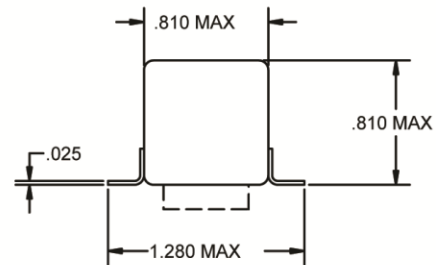
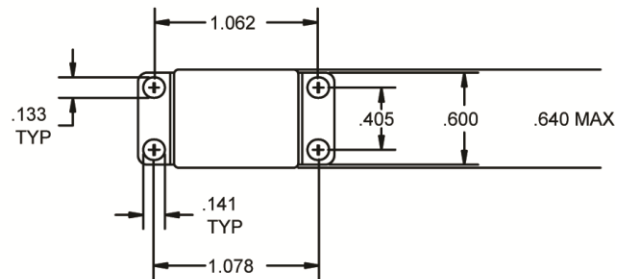

MOUNTING STYLE J

Dimensions in inches
Tolerances, unless otherwise specified, XX ± 0.03 in., XXX ± 0.010

TERMINAL TYPES

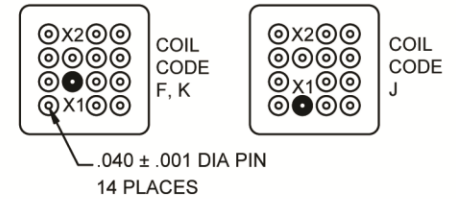
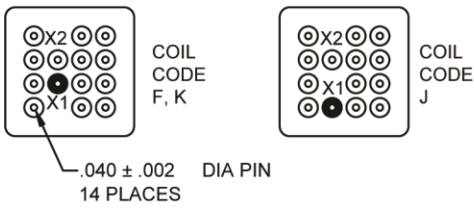
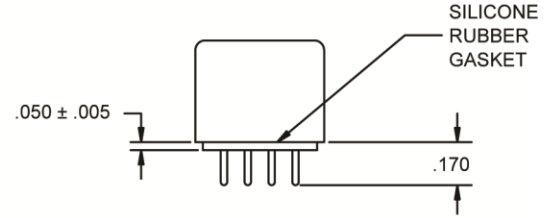
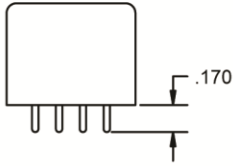

TERMINAL TYPE 1

FINISH:
BODY-TIN/LEAD
TERMINALS-TIN/LEAD

TERMINAL TYPE 4

FINISH:
BODY-TIN/LEAD
TERMINALS-GOLD PLATED

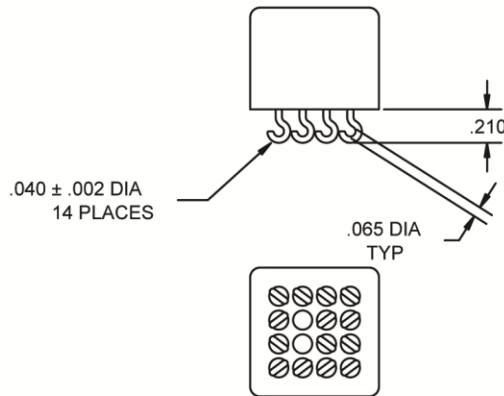

TERMINAL TYPE 2

FINISH:
BODY-TIN/LEAD
TERMINALS-TIN/LEAD

Dimensions in inches
Tolerances, unless otherwise specified, XX ± 0.03 in., XXX ± 0.010

DIAGRAMS

SCHEMATIC DIAGRAM

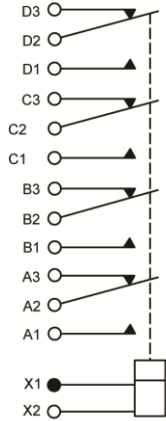

WIRING DIAGRAM

COIL POLARITY NOT APPLICABLE

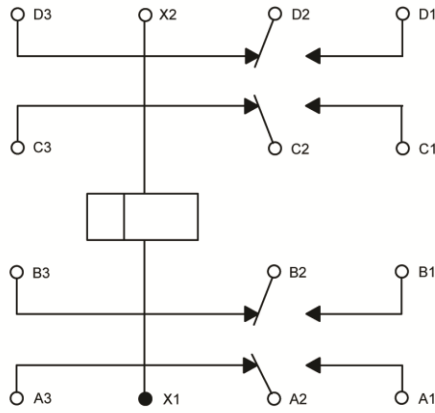

STANDARD TERMINAL LAYOUT

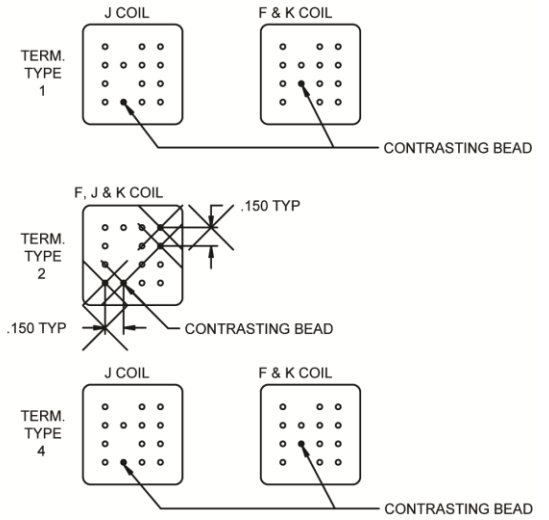

NUMBERING SYSTEM

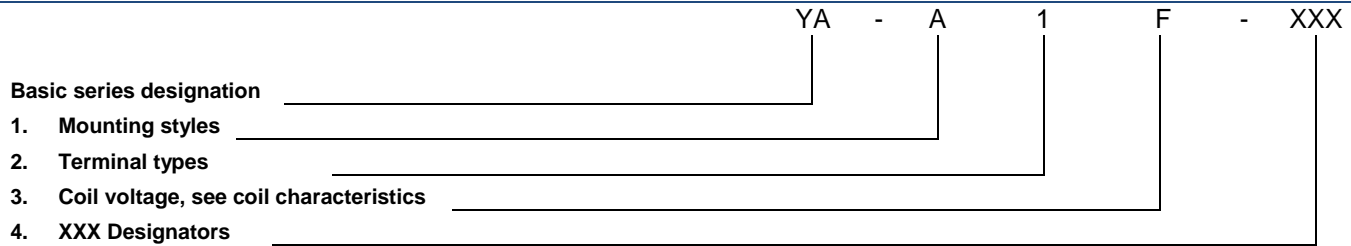

NOTES

1. Standard Intermediate current test applicable. Relay can also switch low level load while switching any of the other rated loads on adjacent contacts.
2. Inductive load life, 10,000 cycles.
3. Low level endurance test: contact load of 10 to 50 millivolt, 10 to 50 microamp, 100 Ohm max. contact resistance.
4. Refer to MIL-PRF-83536 for details.
5. 500 Vrms with silicone rubber gasket compressed, 250 Vrms all other conditions.

For any inquiries, please contact your local sales representative: leachcorp.com